

17.) $\mathcal{E}_1 = 60V$ $\mathcal{E}_2 = 10V$ $R_1 = 8\Omega$ $R_2 = 2\Omega$ $R_3 = 4\Omega$ $R_4 = 6\Omega$ $R_5 = 12\Omega$

$C_1 = 4\mu F$ $C_2 = 6\mu F$

a.) $I_1 = ?$ b.) $Q_1 = ?$

$R_e = \sum R_i$ soros

$\frac{1}{R_e} = \sum \frac{1}{R_i}$ párhuzamos

Kirchhoff 1: $\sum I_i = 0$

Kirchhoff 2: $\sum U_i = 0$

a.)

$R_{23} = R_2 + R_3$

$R_{45} = \frac{R_4 R_5}{R_4 + R_5}$

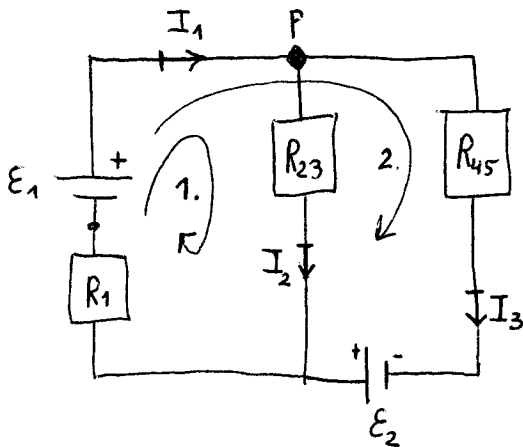

stationárius eset: kondenzátor szakadás
($I = 0$)

Pusomópont: $I_1 = I_2 + I_3$

hurok 1.: $\mathcal{E}_1 - I_2 \cdot R_{23} - I_1 \cdot R_1 = 0$

hurok 2.: $\mathcal{E}_1 - I_3 \cdot R_{45} + \mathcal{E}_2 - I_1 \cdot R_1 = 0$

3 egyenlet, 3 ismeretlen $\Rightarrow \underline{\underline{I_1}}$

b.)

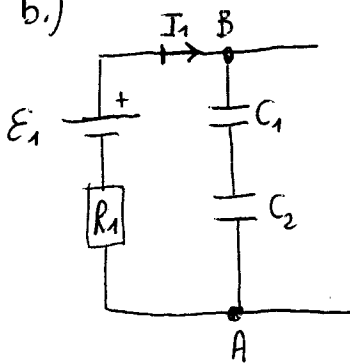

soros:

$Q_1 = Q_2 = Q_{12} = C_{12} U_{AB} = \dots$

$C_{12} = \frac{C_1 \cdot C_2}{C_1 + C_2}$

$U_{AB} = -I_1 R_1 + \mathcal{E}_1$